

# CALCULO DE MEDIDAS PARA CABECERO MARCOS ALUMINIO:

## 1 MONTAJE CORREDERA CASONETO - PARED:

MONTAJE CORREDERA CASONETO - PARED:

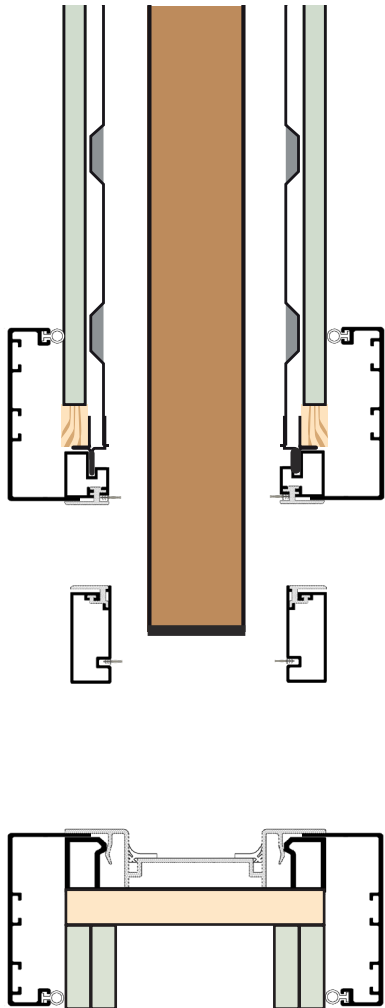

MONTAJE CORREDERA DOBLE CASONETO - CASONETO:

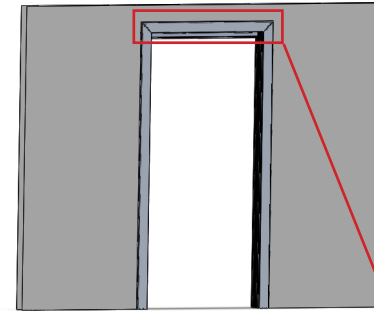
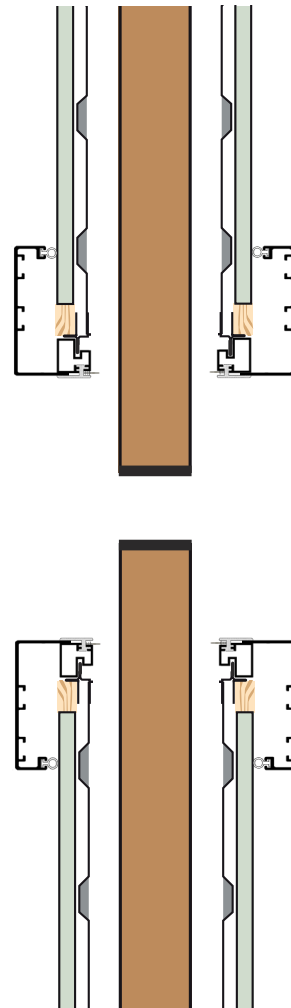

FORMULA CORREDERA CASONETO-PARED:

$$X: ACE - 32,6$$

$$32,6 = -10,6 - 18,80 - 3,2$$

2

MEDIDA "ACE": ES LA QUE DEBE DE APORTAR EL CLIENTE:

ACE = ANCHURA DE HUECO LIBRE SIN MOLDURAS DE ALUMINIO

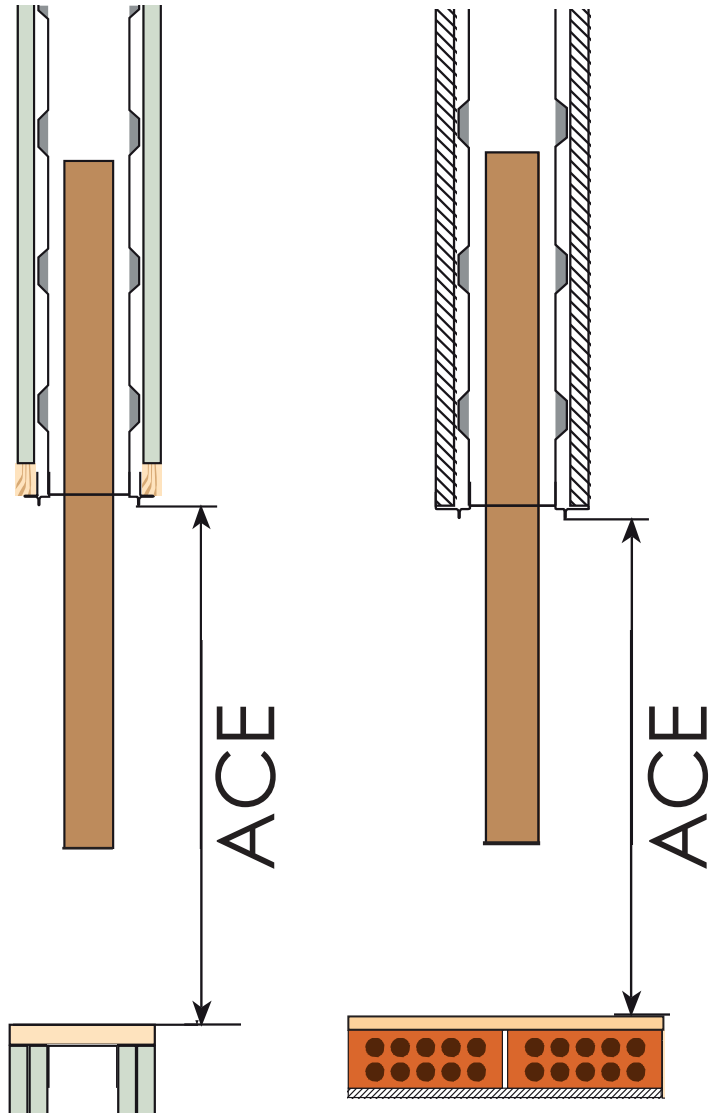

3

MEDIDA 10,6 mm: EXTRAIDA DE PERFIL (B) CLIP CASONETO:

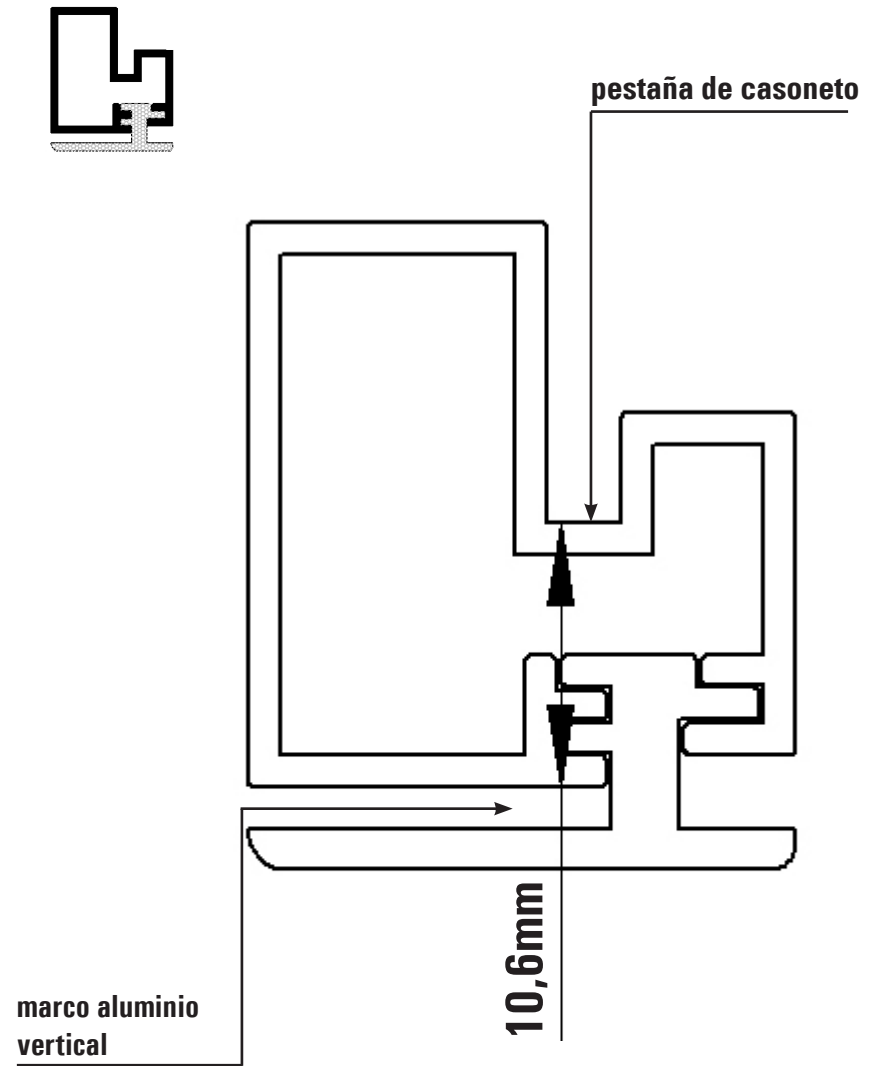

4

MEDIDA 18,8 mm: EXTRAIDA DE PERFIL (C) CLIP PARED:

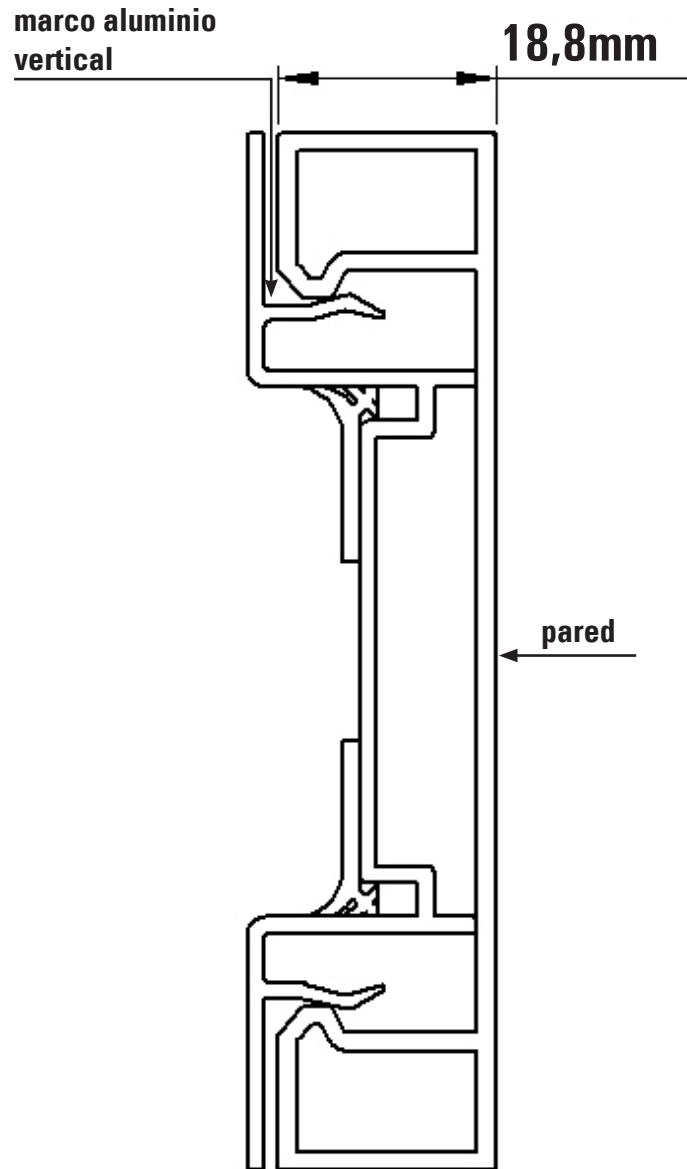

5

MEDIDA 3,2 o (1,6x2): EXTRAIDA DE ESPESOR DE MARCOS VERTICALES

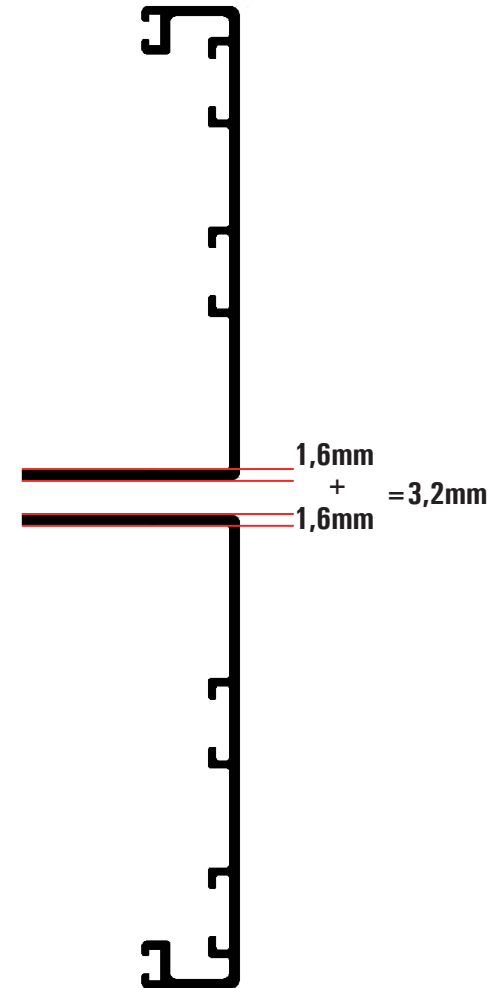

6

**MONTAJE CORREDERA DOBLE CASONETO - CASONETO:**

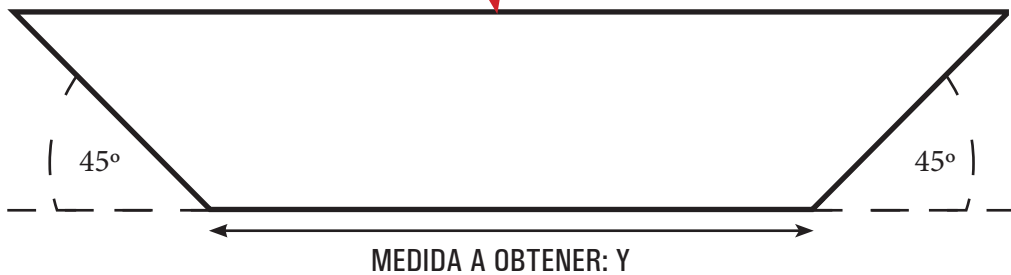
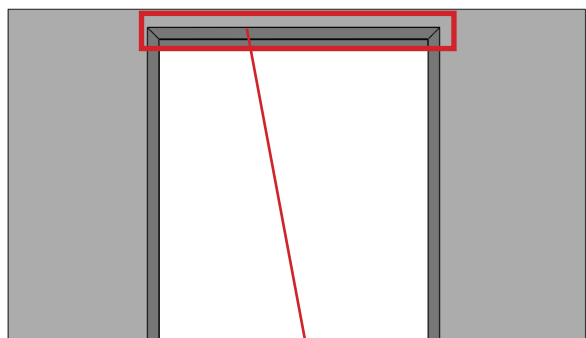

**FORMULA CORREDERA DOBLE CASONETO-CASONETO:**

$Y: ACE - 24,4$ $24,4 = -(10,6 \times 2) - 3,2$
---

7

**MEDIDA "ACE": ES LA QUE DEBE DE APORTAR EL CLIENTE:**

ACE = ANCHURA DE HUECO LIBRE SIN MOLDURAS DE ALUMINIO

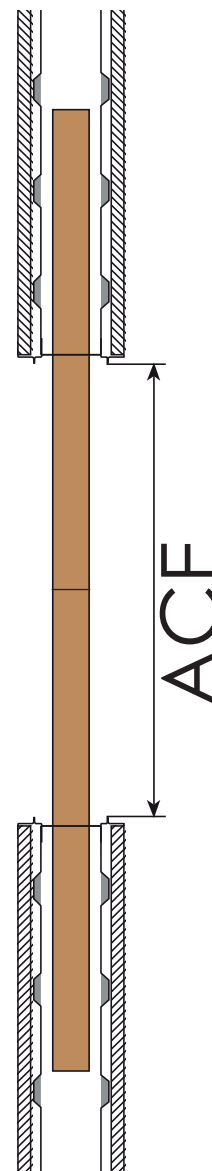

7

MEDIDA 10,6 mm: EXTRAIDA DE PERFIL (B) CLIP CASONETO:

Multiplicada por dos : casoneto izquierdo y casoneto derecho

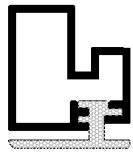

pestaña de casoneto

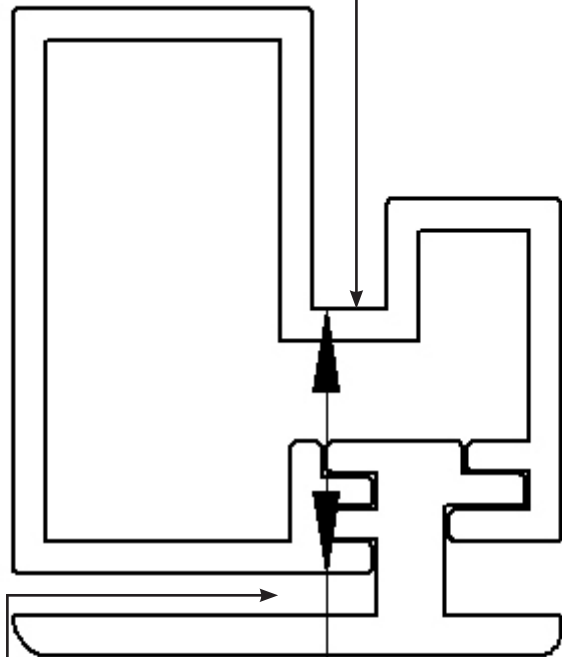

10,6mm

marco aluminio  
vertical

8

MEDIDA 3,2 o (1,6x2): EXTRAIDA DE ESPESOR DE MARCOS VERTICALES

